

St. Paul's Epistle

An Inviting Community of Christ's Disciples

Volume 38 Issue 12

December, 2015

St. Paul's United
Methodist Church

105 E. Main St.

Elida, OH 45807

419-339-3801

officecpc@gmail.com

Rev. Paul Scannell

419/909-9419

Cell Phone: 734/660-1984

pastorespc@gmail.com

4pastorpaul@gmail.com

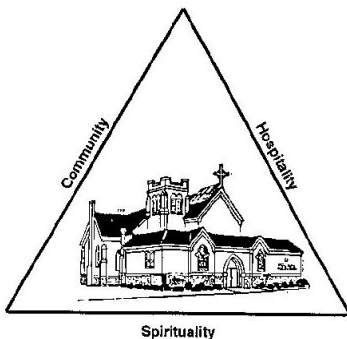

Inside this issue:

Upcoming Events	2-3
Spotlight on Steiners	4
EASY Program	5
Faith In Action	6
Daily Bible Readings	7
Spotlight On Youth	8
Trick or Treat Mission	9
Remember When...	10
Connecting With...	11
The People of St. Paul's	12
December Calendar	13
Recipes	14
Kidz Korner	15
Living Our Faith	16

Advent in the Christian year is that time when we prepare for the coming of Christ, a celebration of God with us. We (me included) buy gifts, decorate, prepare food, go to parties, watch shows and more, more, more. We are so busy we sometimes lose track of what we are celebrating. God's love made real in His promised coming to save us from ourselves. I like the outpouring of love as people share what they have with those in need. Many shelters, food banks, even the Salvation Army raise most of their funds and donations during the 6 weeks before Christmas. All churches I have been affiliated with have used both their Christmas and Easter service offerings to supplement the budget until I showed up at Elida St Paul's. It is one of the things that make you unique and special. Keep up the God work!

There are many things happening around the church in the coming weeks so have fun fellowshiping and I will see you around the building. Cookie and candy sale: have a great variety of really good cookies, but only make your favorite. Donate and buy for a great cause. Come see the decorations and enjoy a warm meal on the house tour. If you're a senior, come enjoy lunch and fellowship at Senior's Day Out. Volunteer to change a child's life at E.A.S.Y. where homework is completed and God's love overflows.

Finally this month I want to talk about Operation Christmas Child and how well that has gone over the last couple of years. Over 160 boxes this year, which means over 160 kids will have a reason to smile and laugh, maybe even receive their first ever Christmas present. I don't know how you do it at your house but at our house it is an adventure. Shopping with kids for other kids is sometimes a challenge but it is all worth it as we gather as a family to pack the boxes. Soccer balls deflated (harder than it sounds), sunglasses wrapped, which doll or stuffed animal in the box, Hot Wheels, Legos, games and toys, boring things like socks and toothpaste with a toothbrush, pretty hair ties, and when we are done a card to say Merry Christmas. Making it all fit is sometimes a chore but Emma seems to make it all fit in that little box. Thank you for making a difference in God's world.

Family together is one of the best things ever, so this Christmas find something to do with your family. And if you are feeling lonely there is always something to do with your church family. It's not about the gifts or the food. There is more than parties and watching your favorite show. We are celebrating God with us. Grace made real so we can live. THE miracle of Christmas.

Merry Christmas,

Pastor Paul



Thought for the Month:

God promises a safe landing,
not a calm passage.

St. Paul's Bi-Annual Holiday Home Walk

Tuesday, December 8, 2015

Soup Supper begins at 5:30 PM
in the Fellowship Hall.

- White Chili
- Beef Vegetable
- Homemade Chicken Noodle
 - Bean

We will visit the homes of
Marla Scannell, Ginny Doseck, and
Sue Theodore.

We still need door prizes!!
They can be dropped off at the
church office.

Hope you can come to join in the
fellowship, food, and fun!

Cookie and Treats Walk December 13, 2015 Following Worship

All those yummy sweets you think of
at Christmastime will be available for you to
sample and purchase.

Buy some items for yourself, your holiday
party, a neighbor, or as a gift exchange item.
(Homemade goodies make the best gifts!) All
the proceeds from this event will be given to
the "Crafty Creatures" small group for quilt
supplies.

Cookie and candy donations are needed to
make this event successful. Bring your items
to the church on Saturday morning, December
12 or early Sunday morning. If you have any
tins that could be recycled from last year,
place them in the Fellowship Hall kitchen.
So, mark your calendar and come downstairs
after worship to experience the Christmas
spirit at St. Paul's and help continue this
mission outreach of our church.

Upcoming Events for St. Paul's

It is time to start making or buying mittens,
scarves, hats and gloves for our special tree.
The items will be taken to Our Daily Bread,
Samaritan House, and Lima Rescue Mission.

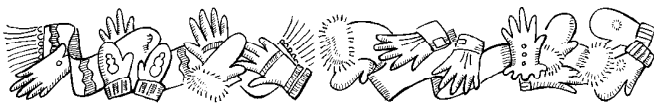

Donate GLOVES & Scarves

Due to the busy Holiday season
and increased volume of mail in
December, we will not accept any
newsletter articles after December
20th, for the January newsletter.

Thank you for your
understanding.



St. Paul's Epistle

is published by St. Paul's
United Methodist Church

Subscription Rate: NONE

Secretary:	Gail Fessler
Secretary:	Jone Lane
Organist:	Linda Holman
Pianist:	Lois Cook
Choir Director	Judy Chaffins
Custodian:	Dave Decker

St. Paul's Book Club
will meet on Saturday,
January 2, 2016

The Shoemaker's Wife
By Adriana Trigiani
will be discussed.



Bring your own
breakfast and join the
discussion group.

December 6th
Coins for Communion
to benefit
Lima Salvation Army

**Seniors Day Out
Tuesday
December 15, 2015**
**Guest: Troy Reineke,
pianist, will play all
things Christmas.**



**Choir Cantata
December 20, 2015**

The St. Paul's Chancel Choir will perform the Christmas cantata: **Rise Up! A New Light A-Comin'** by Lloyd Larson and Pamela Martin on Sunday, December 20, during the worship hour. This telling of the gospel story is a response to the powerful call, "Children, go where I send thee." It is the sending out of people to share the good news of the birth of our Savior. The cantata is an inventive mixture of spiritual and carol arrangements with newly composed music to punctuate that gospel call with joyous harmonies and lush melodies.

Come be a part of the musical tribute to this celebration of the inspiring story of: prophets sent to prepare the way for the promise of redemption in the coming Messiah; angels sent to carry the news to Mary; Mary and Joseph sent to Bethlehem to humbly bear God's Son; shepherds sent to worship the Child in the manger; wise men sent from distant orient lands with precious gifts for the Child; and, finally, Christians today sent into the world to proclaim the gospel message that a new light is coming.

Marty White will narrate this message, choir members will sing, and visuals will enhance the experience. All are invited to immerse themselves in the Christmas message and experience the hope, promise and peace it offers.

Upcoming Events for St. Paul's



December 6, 2015
**2nd Sunday of
Advent**



December 13, 2015
**3rd Sunday of
Advent**



December 24, 2015
**Christmas Eve
Early Service 6:00 PM**



December 20, 2015
**4th Sunday of
Advent**



December 24, 2015
**Christmas Eve
Candle light Service
10:00 PM**

Spotlight on Ron and Mary Steiner

26 years in 4-H and the Allen Co. Fair

Gail ask me to write an article on our 26 years of being a 4-H advisor and a rabbit barn superintendent. It all started in 1989 three years after Mary had her brain bleed. I was concerned how Mary would get along with all the kids at the fair. I never thought that it would be like it was.

It started out with Brian & Krista Holman being members of the club. I was asked to be a 4-H advisor as a helper, and the following year to help at the fair. That lasted about 3 years, then I found myself and Tim Hall, who started 1 year after I did, becoming the lead advisors. We had 3-4 helpers. Then we asked Carla Oberly to become an advisor. We three became great friends and the core three of the club and the rabbit barn.

Our club was the Bunny Boosters located in Harrod. It had been quite a few years before we took over. Our membership stayed around 40 to 60 each year. As I had said, I was concerned about Mary with the kids: she was the favorite of all the kids. There were a few times when the kids and the parents could not decide what to do with the money we raised from a fund raiser. They would ask Mary and she would pick the place to give it to. After a few years we became friends with so many families, the record for graduation parties was 14 and 4 weddings in one year. Mary cried at all of them. We have older member's kids now in the club. We still keep in touch with so many of the members from past years. To me there are two kinds of 4-H members: ones that need 4-H and ones that 4-H needs them. It is fun to see the change from one to the other. They want to lead and help the young ones. A dear friend, Allie, who is a senior at Ohio State, is a great example of this. She wrote a paper on the most important turning point in her life. She told how she was in 4-H the first year and when it was her time to give a demonstration she was shaking. I put my arm around her while she talked above a whisper; thus started our friendship. In a few years we convinced her she could be an officer, then rabbit barn queen, then the fair queen. We still keep in touch at least once a month.

As the rabbit barn supt., when Tim and I started, we were in the old chicken barn with the chickens. We have grown from 150 rabbits to 850 this year. It takes most of the month of August. When we all got to the fair Mary got to see all the other kids from the other clubs, and them to see her. One day we took a break from judging. The judge sat in Mary's chair. Tim was talking to him and up came a small boy and said that he had to move he was in Mary's chair. He said he would when she came back. The boy left. A little bit later about a dozen kids came up and said he was getting out of Mary's chair or it was going to get ugly. He is a deputy sheriff now and still checks on Mary.

People ask if we will miss the fair, 4-H, and the whole fair family. Sure we will miss it a lot. I am sure Mary will cry some. After all, the only time she left the fair in 26 years was for the birth of two grandkids. But we both agree it is time to move on and let others take over. We are tired of all the responsibility and the hard work. Yes, we will go to the fair a lot but just to be there. This was a great blessing for both of us the past 26 years.

Ron & Mary Steiner



EASY Report

Elida After School Youth Program (EASY)

EASY and EASY 2.0 are Going Strong

We are going at full-tilt with the EASY and EASY 2.0 programs! We spent the first month getting to know each other and having guest speakers. Rev. Sam Payne from New Creation Lutheran Church spoke to both groups about Liberia's culture and his life in both Africa and the United States. We also started a monthly program, Expect Respect, through Crime Victims Services, led by Mike Tarbet. EASY 2.0 will focus on SafeTeens leadership training. This will help our students become role models, leaders, and peer helpers in Interpersonal Violence Issues. The younger students at EASY will work on the idea of cyber bullying and what to do about it.

During November, we have begun interest groups. There is one on jewelry making, African drums, food, games, and art, and making table top corn hole games, complete with sewing the bags on our new, recently donated, sewing machine. These are keeping EVERYONE busy, volunteers and students alike.

In December we will be celebrating Christmas! Foods, crafts with pinecones, finishing projects from November and a speaker from another country who will share Christmas customs and projects from home, as well as another visit from Mike Tarbet will keep us moving.

The strong point of EASY has always been the relationships built between students and volunteers. During October, volunteers spent 334 hours helping with the program. Thank you, Volunteers! Thank you also to those who have given materials, food, supplies, and equipment. Your gifts are invaluable (However, if you want to put a value on them for the IRS, let us know. We can provide a donation form.)

BUT: Projects + homework help + activities for when there is no homework = a need for help! Time spent getting to know students one-on-one during study or project time is what keeps kids and families going through the middle school growing pains. People leading new projects to teach independent living skills or leisure time skills help expand students' life skills and develop interests. There are times when "life" interferes with volunteers coming to our programs. We can always use more help on a regular basis, for interest groups, to play games, or even an emergency on-call basis for when our regulars are unable to attend. Please consider joining us and showing the children and families in our community Christ's love.



Faith In Action

Worship Attendance:

November 1, 2015	87
November 8, 2015	103
November 15, 2015	96
November 22, 2015	110

Financial Giving

Weekly Need for
Unified Ministry Budget
\$3,466.00



Unified Ministry Giving:		Other:
November 1, 2015	\$3,635.00	\$471.31
November 8, 2015	\$6,326.00	\$246.96
November 15, 2015	\$3,211.00	\$473.00
November 22, 2015	\$2,234.91	\$420.35

Sunday School Attendance

November 1, 2015	13
November 8, 2015	21
November 15, 2015	19
November 22, 2015	18

Greeters

December 6, 2015	Marty & Kathy White
December 13, 2015	Dillon & Helen Staas
December 20, 2015	Jerry & Becky Bean
December 25, 2015 (6:00 PM Service)	Cody & Paul Scannell
December 25, 2015 (10:00 PM Service)	OPEN
December 27, 2015	Ray & Phyllis Trigg

Communion Servers December 6

Station #1	Corinne Piper & Channing Poling
Station #2	Marla & Cody Scannell
Station #3	David Scannell & Samm

Flower Calendar

December 6, 2015	Dan & Margie Best
December 13, 2015	Dennis & Shara Bowsher
December 20, 2015	Poinsettias
December 27, 2015	Poinsettias

Daily Bible Readings

Tuesday 12/1

Psalm 5, 6, 10, 11, Amos 3:1-11
2 Peter 1:12-21, Matthew 21:12-22

Wednesday 12/2

Psalm 12, 13, 14, 119:1-24
Amos 3:12-4:5
2 Peter 3:1-10, Matthew 21:23-32

Thursday 12/3

Psalm 18, Amos 4:6-13
2 Peter 3:11-18
Matthew 21:33-46

Friday 12/4

Psalm 16, 17, 22, Amos 5:1-17
Jude, Matthew 22:1-14

Saturday 12/5

Psalm 20, 21, 110, 116, 117
Amos 5:18-27
Matthew 22:15-22

Sunday 12/6

Psalm 114, 115, 148, 149, 150
Amos 6:1-14
1 Thessalonians 5:1-11
Luke 1:57-68

Monday 12/7

Psalm 9, 15, 25, Amos 7:1-9
Revelation 1:1-8
Matthew 22:23-33

Tuesday 12/8

Psalm 26, 28, 36, 39
Amos 7:10-17, 24-25
Revelation 1:9-16
Matthew 22:34-46

Wednesday 12/9

Psalm 38, 119:25-48, Amos 8:1-14
Revelation 1:17-2:7
Matthew 23:1-12

Thursday 12/10

Psalm 37, Amos 9:1-10
Revelation 2:8-17
Matthew 23:13-26

Friday 12/11

Psalm 31, 35, Haggai 1:1-15
Revelation 2:18-29
Matthew 23:27-39

Saturday 12/12

Psalm 30, 32, 42, 43
Haggai 2:1-19
Revelation 3:1-6, Matthew 24:1-14

Sunday 12/13

Psalm 63, 98, 103, Amos 9:11-15
2 Thessalonians 2:1-3, 13-17
John 5:30-47

Monday 12/14

Psalm 41, 44, 52
Zechariah 1:7-17
Revelation 3:7-13
Matthew 24:15-31

Tuesday 12/15

Psalm 45, 47, 48
Zechariah 2:1-13
Revelation 3:14-22
Matthew 24:32-44

Wednesday 12/16

Psalm 49, 53, 119:49-72
Zechariah 3:1-10
Revelation 4:1-8
Matthew 24:45-51

Thursday 12/17

Psalm 33, 50, Zechariah 4:1-14
Revelation 4:9-5:5
Matthew 25:1-13

Friday 12/18

Psalm 40, 51, 54
Zechariah 7:8-8:8
Revelation 5:6-14
Matthew 25:14-30

Saturday 12/19

Psalm 55, 138, 139
Zechariah 8:9-17
Revelation 6:1-17
Matthew 25:31-46

Sunday 12/20

Psalm 8, 24, 29, 84
Genesis 3:18-15
Revelation 12:1-10
John 3:16-21

Monday 12/21

Psalm 61, 62, 112, 115
Zephaniah 3:14-20
Titus 1:1-16, Luke 1:1-25

Tuesday 12/22

Psalm 66, 67, 116, 117
1 Samuel 2:1-10
Titus 2:1-10, Luke 1:26-38

Wednesday 12/23

Psalm 72, 111, 113
2 Samuel 7:1-17
Titus 2:11-3:8a, Luke 1:39-56

Thursday 12/24

Psalm 89:1-29, Isaiah 59:15b-21
Philippians 2:5-11

Friday 12/25

Psalm 2, 85, 110, 132,
Micah 4:1-5, 5:2-4
1 John 4:7-16, John 3:31-36

Saturday 12/26

Psalm 34, 93, 96, 1 Samuel 1:1-28
Hebrews 2:10-18
Matthew 1:18-25

Sunday 12/27

Psalm 18, 2 Samuel 23:13-17b
Revelation 1:1-8, John 7:37-52

Monday 12/28

Psalm 20, 21, 23, 27
1 Kings 17:17-24
Revelation 1:9-20, John 7:53-8:11

Tuesday 12/29

Psalm 46, 48, 1 Kings 3:5-14
2 Corinthians 5:16-6:2
John 8:12-19

Wednesday 12/30

Psalm 90, Isaiah 65:15-25
Revelation 21:1-6

Thursday 12/31

Psalm 103, 148
Isaiah 62:1-12
Colossians 2:6-12
John 16:23b-30

Spotlight On Youth

Thank you to the many fans from St. Paul's that came out to support the Elida Boys soccer team at the Regional semi-finals at Findlay High School. Elida beat Oak Harbor 2-1 in overtime!



Congratulations to the Elida Boys soccer team for being the Division II district winners and went on to play in the elite 8 bracket. They ended their season as Division II Regional Runners up.

Photo provided by Campbell Photography



Congrats to Isaac McAdams for having a good year as quarterback of the Elida JV Football Team and as backup Quarterback on the Varsity Football Team. Good luck for next season.



Reggie McAdams is a starter this year for the Akron Zips Men's Basketball Team. In their first two games Reggie has scored in double figures and played solid defense. Good luck, Reggie on your senior year!"

Trick or Treat Mission

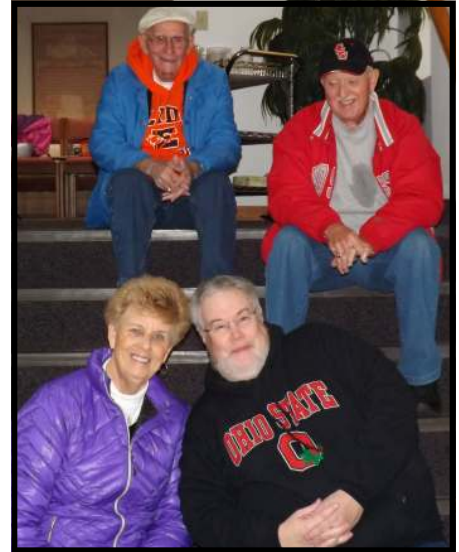

On October 29th, St. Paul's participated in a mission to provide hot chocolate and coffee to Elida children who were trick-or-treating, and their parents. Thank you to Jerry Crates, Gary Hurd, Mary and Don Irvin, Tim and Corinne Piper, Jean Thompson, and A J White for serving hot drinks and passing out pencils.



Dr. Lena Whetstone at Primrose on trick or treat night. Lena is checking out Jo Hurd's heart.



Remember When...



December, 1997
St. Paul's Youth Group
Playing "Twister"



December, 2001
Honoring Rev. Terry Heck



December, 2005
Making Christmas Gifts for Shut-Ins
L-R: Oliver and Gail Fessler, Janna and
Aric Thompson, Torie McAdams



Connecting With ...

Congratulations to Derick and Ashley Edwards on the birth of their twins, November 20th. Brody Alan weighed 6 lbs. 3 oz. and his sister, Brinley Jo, weighed 5 lbs. 13 oz. Great grandparents are Dwain and Myrna Metzger and Mary LaRue is the great, great grandmother. Cards will reach Derick and Ashley at 4946 East Road, Elida, OH 45807.



Remember in Prayer

Recovering from Surgery or in the Hospital

Fran Hall
Beth Warris

Homebound Members

Hazel Dunn
Jean Redd

Those in Need of Healing, Support, Strength & Encouragement

Karen Bible
Joanna Hurd

In the Military & Missions

Dani Milke



Jan Wyant, Christian Education, presented 3rd grader Ian House with his own Bible on Sunday, November 15.

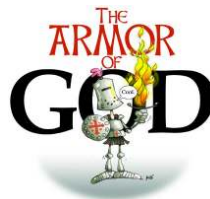

Christian Symbol



This Latin word for peace is frequently seen in Christmas art and decorations, reminding us that Jesus came as the Prince of Peace (Isaiah 9:6). After announcing the Savior's birth to the shepherds, the angels sang, "Glory to God in the highest, and on earth peace" (Luke 2:14, NKJV).



The People of St. Paul's

Pastor Paul,

Thanks so much for taking the time to be with us in Columbus, during my hospital stay. Your presence meant a lot to us and touched our hearts.

*Thank You,
Scott and Beth Warris*

*Thank
You*

Crafty Creatures,

Thanks so much for my prayer blanket. Your thoughtfulness meant so much..

*Thank you,
Beth*

Thank so much for all your prayers, cards, and Angel flower arrangement during my recent hospital stay. It truly means a lot to me.

*Thank you,
Beth*

OPERATION CHRISTMAS CHILD



Thanks to your generous support we were able to deliver **163 shoeboxes** to TV 44 for distribution to Operation Christmas Child. These shoeboxes can travel anywhere in the world to touch the lives of children who may have never heard the name of Jesus. Each shoebox will have a pamphlet included called ***The Greatest Journey***, that will tell the Gospel story in their own language.

These pamphlets can bring the children to salvation in Jesus name. Because you cared enough to pack and send the shoeboxes children and their families are being saved and churches are being started.

Just because we have packed and sent the shoeboxes doesn't mean our work is done. We need to continue to pray for the shoeboxes and those that will receive them anywhere in the world. Some of you printed tracing labels for your shoeboxes so you will be notified of their final destination. The rest of us will never know where they went but through faith we will know that they are being used, by God, where they are needed most.

It's never too early to start setting aside items for next year's OCC shoeboxes. In fact, there are left over boxes in the church office if you would like to start packing them early. I will be announcing sometime in mid-2016 when we will start some projects to support our OCC shoebox collection for next year.

Whenever anyone receives a report of the final destination of their shoeboxes, please let the congregation know so we can all rejoice in gifts being delivered.

OCC Coordinator,
Jamie Wyant

Meetings

December 1, 2015
Trustees...7:00 PM

December 2, 2015
Worship...6:00 PM

December 7, 2015
PPR...7:00 PM

December 14, 2015
Finance Meeting

No Ad Council

TBA
Missions

Sundays
Prayer...8:45 AM
Sunday Sch...9:00 AM
Fellowship...9:30 AM
Worship...10:00 AM

Wednesdays
Chancel Choir...7:00 PM

December 2015

Sun Mon Tue Wed Thu Fri Sat

		1 Lena Whetstone A.J. White	2 Michael Craft Lavonne Segovia	3 Mary LaRue 96 years	4	5 Shirley Adams David Segovia
6 Jerry Crates Sue Theodore	7	8	9	10	11 John Segovia Phyllis Trigg	12
13	14	15 Taryn Piper	16	17 Audrey Fox	18 Pam Gaghen Mary Holmes	19
20 Ruth Burgoon Mary Steiner	21	22 Kara Woeller	23	24 Linda Craft 	25 Denny Grapner 	26
27 Deb Hurd Megan Wyant	28	29 Tammy Segovia	30 Tristan Gaghen	31 Jack White 		

Anniversaries

*Roger & Jackie Henderson
December 4*

*Derick & Ashley Edwards
December 18*

*Dennis & Shara Bowsher
December 19*

*Larry & Gloria Brunk
December 21*

*John & Val Kuenzli
December 27*

*Denny & Janna Thompson
December 29*

*Ron & Karen Bible
December 30*

*Mike & Kim Crates
December 31*

Featured Recipes from St. Paul's Cookbook

Orange Chocolate Chip Cake

By Mary Irvin

Ingredients		Instructions
1	Orange cake mix	Beat 2 minutes by hand. Stir in chocolate and white chips. Pour into greased Bundt pan. Bake at 350 degrees for 45-50 minutes. Cool cake. Melt 1/2 can chocolate frosting. Pour over cake. Can be served with ice cream. Options: Use caramel cake mix , chocolate chips and caramel frosting. Use spice cake mix, butterscotch chips and white frosting.
1 small	Instant vanilla pudding	
2	Eggs	
2 cups	Milk	
1/2 cup	Chocolate chips	
1/2 cup	White chocolate chips	
1/2 tsp.	Orange extract	



Crock Pot Pork Chops

By Ron Steiner

Ingredients		Instructions
6	Pork chops, medium to thick	Place 3 pork chops on bottom of crock pot. Layer remaining 3 pork chops on top of those. Add 1 can of Cream of Chicken soup. Do not add water. Add packet of dry Hidden Valley Ranch dressing. Cook on high for 4 hours. Put on lid and leave it.
1 can	Cream of chicken soup	
1 packet	Hidden Valley Dry Ranch Dressing	



KIDZ KORNER

STAR OF BETHLEHEM

Make a mobile to remind you of Jesus' birth.

What you need:

- Paper plate
- Hole punch
- Thin blue ribbon
- Scissors
- Pencil
- Yellow craft foam
- Marker

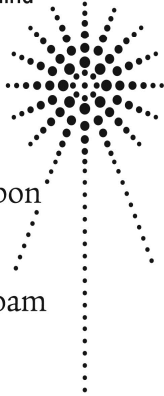

What you do:

1. With the paper plate upside down, punch evenly spaced holes along the rim. Gently fold the plate and punch a hole in the center.
2. Cut pieces of ribbon, thread them through the holes as desired and tie the ribbons securely.
3. Trace several small stars and one larger star on the foam and cut them out. Punch a hole atop a point of each star.
4. Tie one small star to each outer-rim ribbon.
5. Thread a longer ribbon through the center hole and tie the large star to the other end.
6. Write a verse on the plate or large star. Hang the mobile from the ceiling with another piece of blue ribbon.

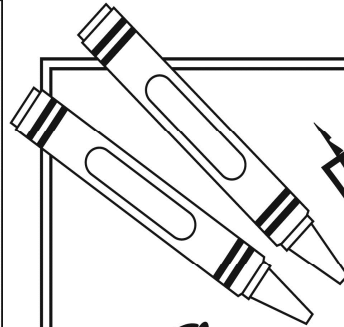

PUZZLE

The star of Christmas

When Jesus was born, a star led the wise men to him.

Directions: Place the words in order, by their numbers, on the blanks below to complete Matthew 2:10, NIV.

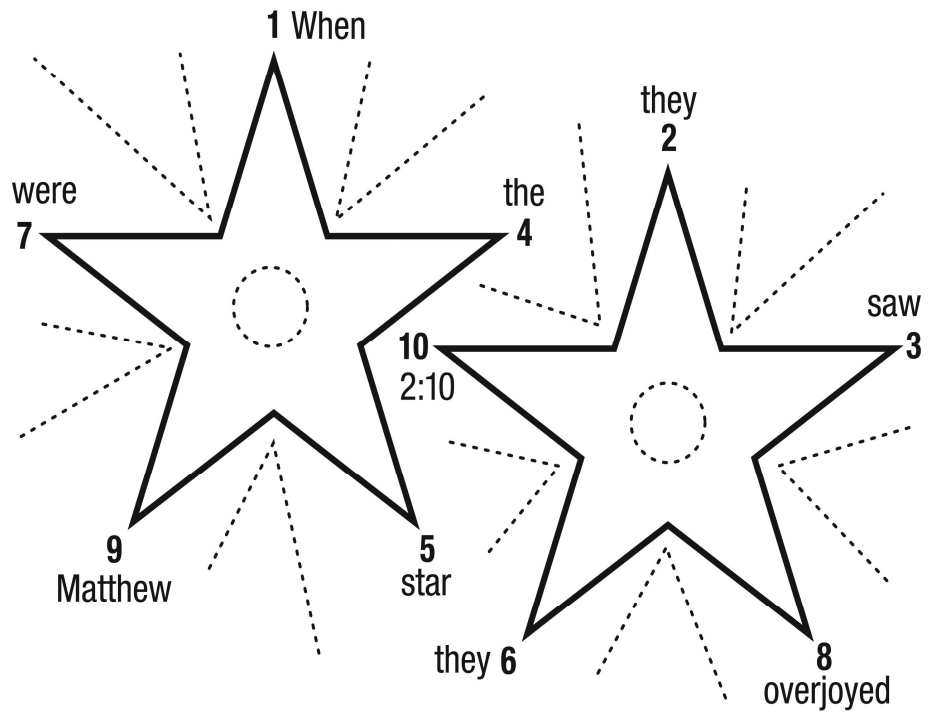

“ _____ , _____ , _____ ”
 _____ : _____ , NIV

Answer: "When they saw the star, they were overjoyed." Matthew 2:10, NIV

St. Paul's United Methodist Church105 E. Main St.
Elida, OH 45807

*Return Service Requested

Non-Profit
Organization
U.S. Postage
PAID
Elida, OH
45807
Permit No. 71**Our Web Address:**
www.elidastpaulschurch.org

Living Our Faith

How Far to Christmas?



How far is it to Christmas Day? The journey's just as long as taking time to listen to a joyful angel song. It's just as far as one can go in doing a loving deed that helps someone feel better or that meets their special need. For Christmas is a journey that the heart makes every year. It starts right with your family and those you hold so dear. It travels on to strangers 'round the world to everyone with the message that God loves us and that's why he's sent his Son!

Peggy Ferrell

Breathless Anticipation

In *Whistling in the Dark* (HarperOne), Frederick Buechner compares Advent to the moments right before a symphony conductor raises the baton to begin a much-anticipated performance. "You hold your breath to listen," he writes. "You are aware of the beating of your heart. The extraordinary thing that is about to happen is matched only by the extraordinary moment just before it happens. **Advent** is the name of that moment."

During December, silence can seem elusive, Buechner admits. But "if you concentrate just for an instant, far off in the deeps somewhere you can feel the beating of your heart. For all its madness and lostness, not to mention your own, you can hear the world holding its breath."

